

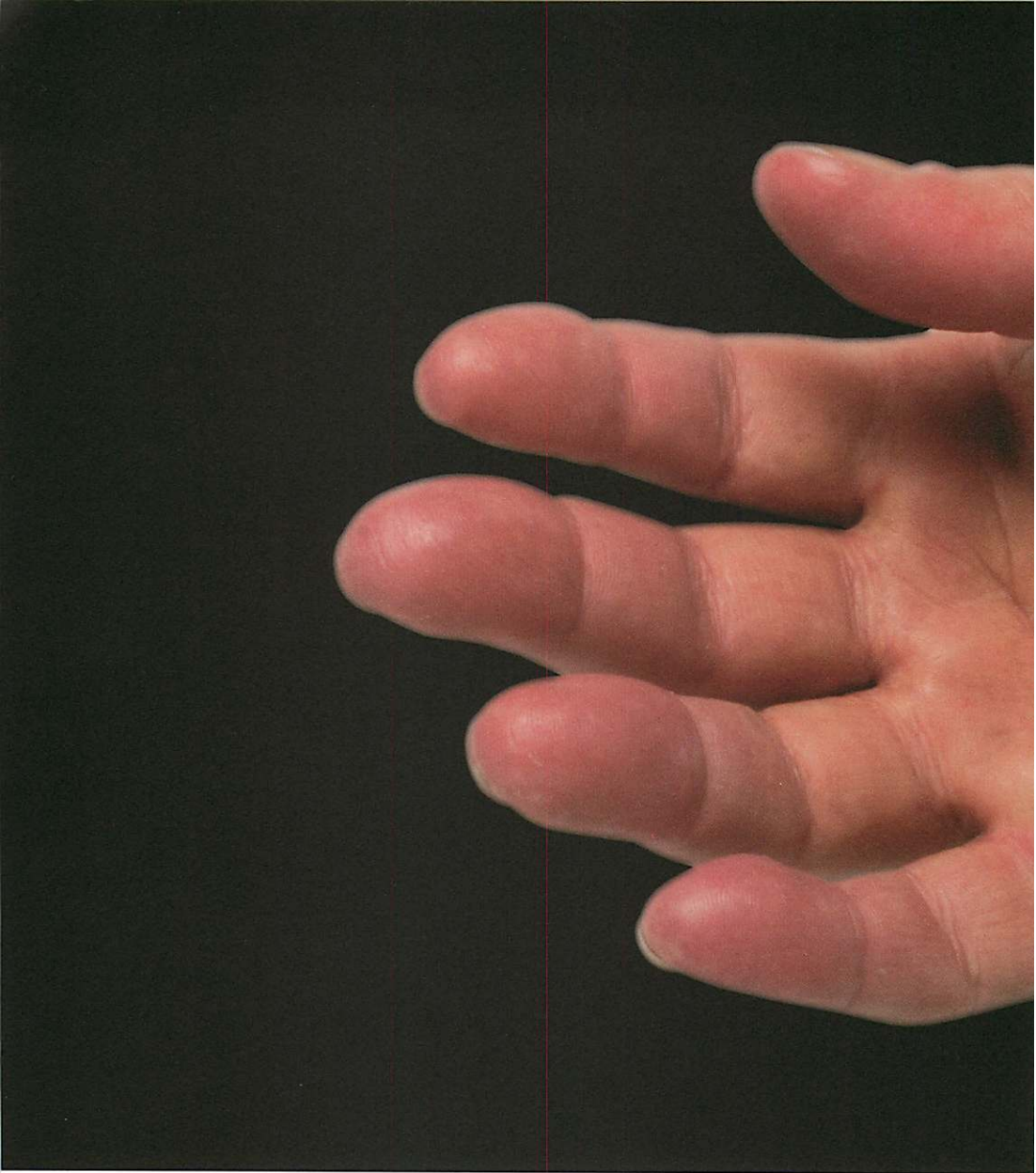

LIVINGSKIN™

Functional Aesthetic Restoration

A reflection of you.





LIVINGSKIN™

Functional Aesthetic Restoration



we do

An aerial, high-angle photograph of a diverse group of people walking on a light-colored, possibly concrete, floor. The people are scattered across the frame, some walking in groups, some alone. The image is partially obscured by a yellow banner at the top and a larger yellow box at the bottom right containing text.

LIVINGSKIN

Harmony, integration, renewal. For more than ten years, LIVINGSKIN™ aesthetic restorations have successfully delivered these fundamental benefits.

A LIVINGSKIN aesthetic restoration is a complete service - a high-definition silicone prosthesis that is created to resemble human skin by mimicking the three dermal layers of natural human skin. To ensure proper color matching and fit, every prosthesis is custom crafted for each individual.

A LIVINGSKIN product is an aesthetic restoration solution from Touch Bionics – the company that developed and produces the i-LIMB™ Hand.

Life is a balancing act. It's all about interaction with others, at work, at play, in every social context. A LIVINGSKIN aesthetic restoration is all about bringing that balance back into your life.

Whatever your level of absence, a LIVINGSKIN prosthesis is designed to fit the way you are, in every detail. Touch Bionics has taken the lead in the creation and maintenance of silicone skin coverings that are tailored to deliver the best possible result, across all manner of individual needs.

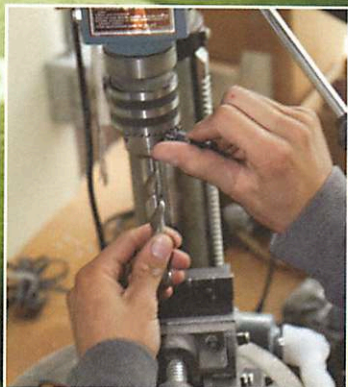

function

LIVINGSKIN

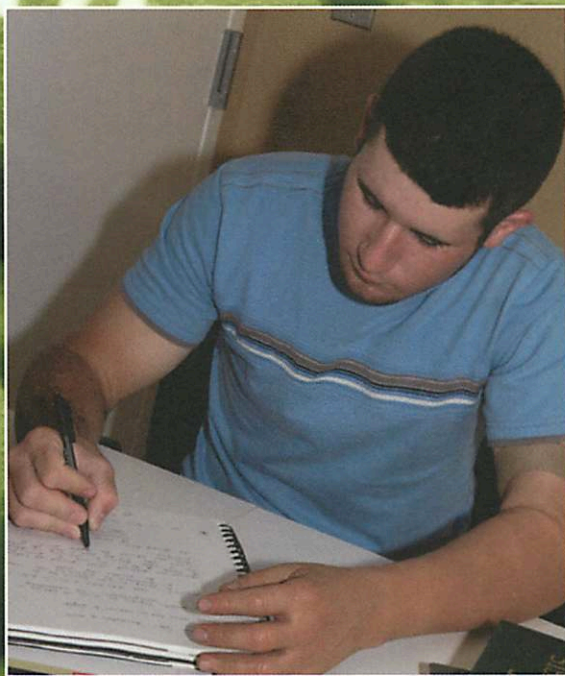

on

Getting on with the things that really matter - going pretty much unnoticed by others. A LIVINGSKIN aesthetic restoration will help to deliver the appearance of normality, at every level of interaction; active, passive, social, emotional and individual. Since the results are so effective, the color matches so close, a LIVINGSKIN prosthesis restores control to you. You'll appreciate this when you hear the words "I never knew" for the first time!

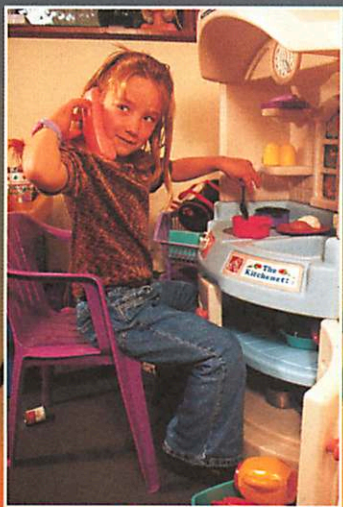

n

LIVINGSKIN

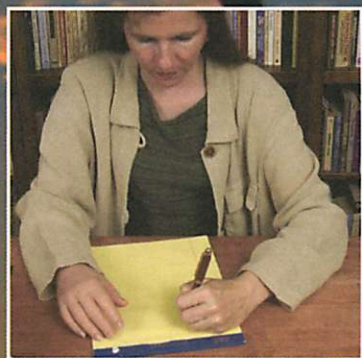
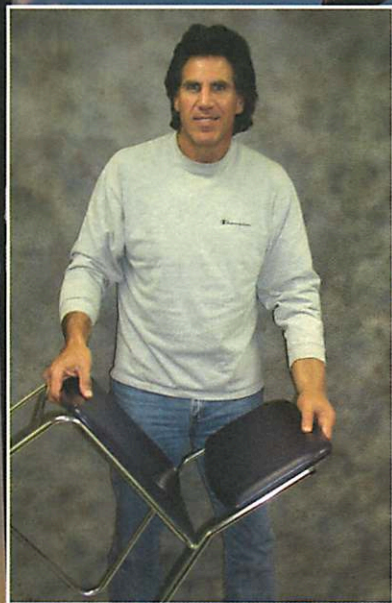

atural

lo

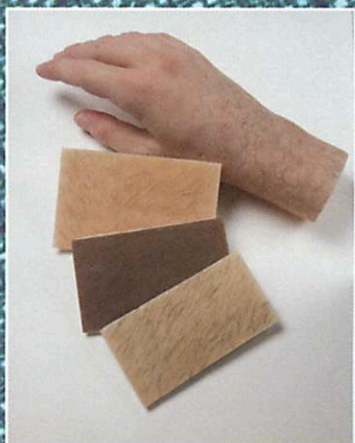

DermaHair™

LIVINGSKIN

ooking



SeasonGuard™

Looking good and feeling good are two sides of the same equation. LIVINGSKIN aesthetic restorations bring more than a simple cosmetic benefit. The detail work that TOUCH BIONICS puts into every creation blends so closely with your natural skin, in tone, color and texture that the distinction is virtually unnoticeable. Tiny surface anomalies, moles, freckles and cuticle variations – nothing is too much.

DermaHair™ can be added, duplicating your natural hair patterns, they don't fade or fall out.

SeasonGuard™ is a self-tanning product that is specially formulated for silicone. Patients may apply as light or as dark as they prefer, and the color lasts for about ten days under UV exposure.

So when you present yourself, it's the clothes you are wearing, the look in your eyes, the smile on your face – these are the things that get noticed.

Finger Restoration



Hand Restoration

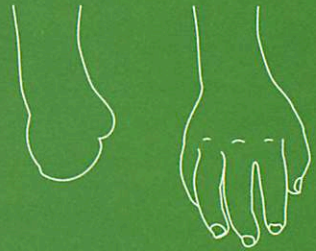

Arm Restoration

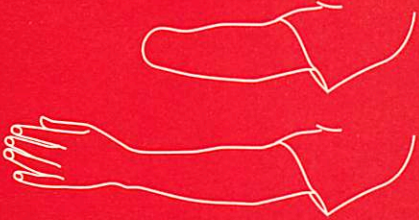

Lower Limb Restoration

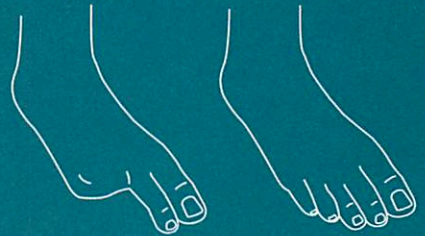

Aesthetic Restoration

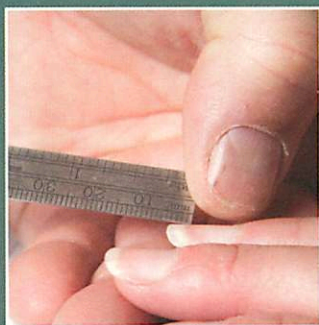

LIVINGSKIN finger prostheses can be created and fitted for any level of amputation or loss. Most are attached by suction over the remaining portion of the affected finger or fingers. Where a finger is totally absent other methods are used to anchor the prosthesis. All are custom crafted for a correct fit, likeness, color and character.



Finger Restoration



ingers

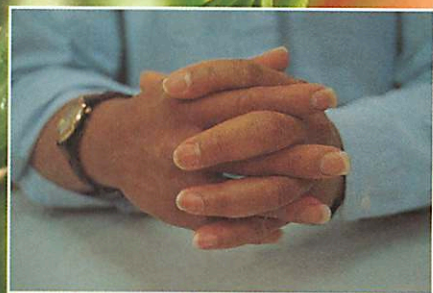
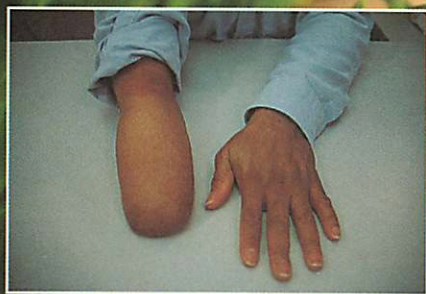

hand

Hand Restoration

A LIVINGSKIN aesthetic hand prosthesis is usually attached by suction and is built around passive and adjustable strengthening rods that enable positioning. The opposing hand can discretely bend the fingers into a desired position, maximizing both the passive and active functionality.

The covering's strength and flexibility make them the ideal covering for a wide range of mechanical prostheses, including the I-LIMB Hand. LIVINGSKIN covers create the most natural and secure sense of feedback when powered movement is utilized.



S

LIVINGSKIN forearm prostheses allow increased active and passive function. Wrist rotators can be included for rotation (pronation and supination) of the hand.

Above elbow prostheses can be designed to cater for a variety of needs - and hook wearers can easily interchange their hand whenever they need to.

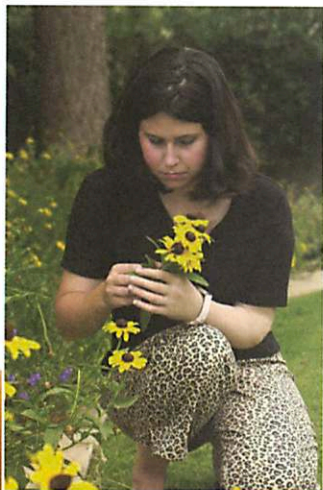

arms

Arm Restoration

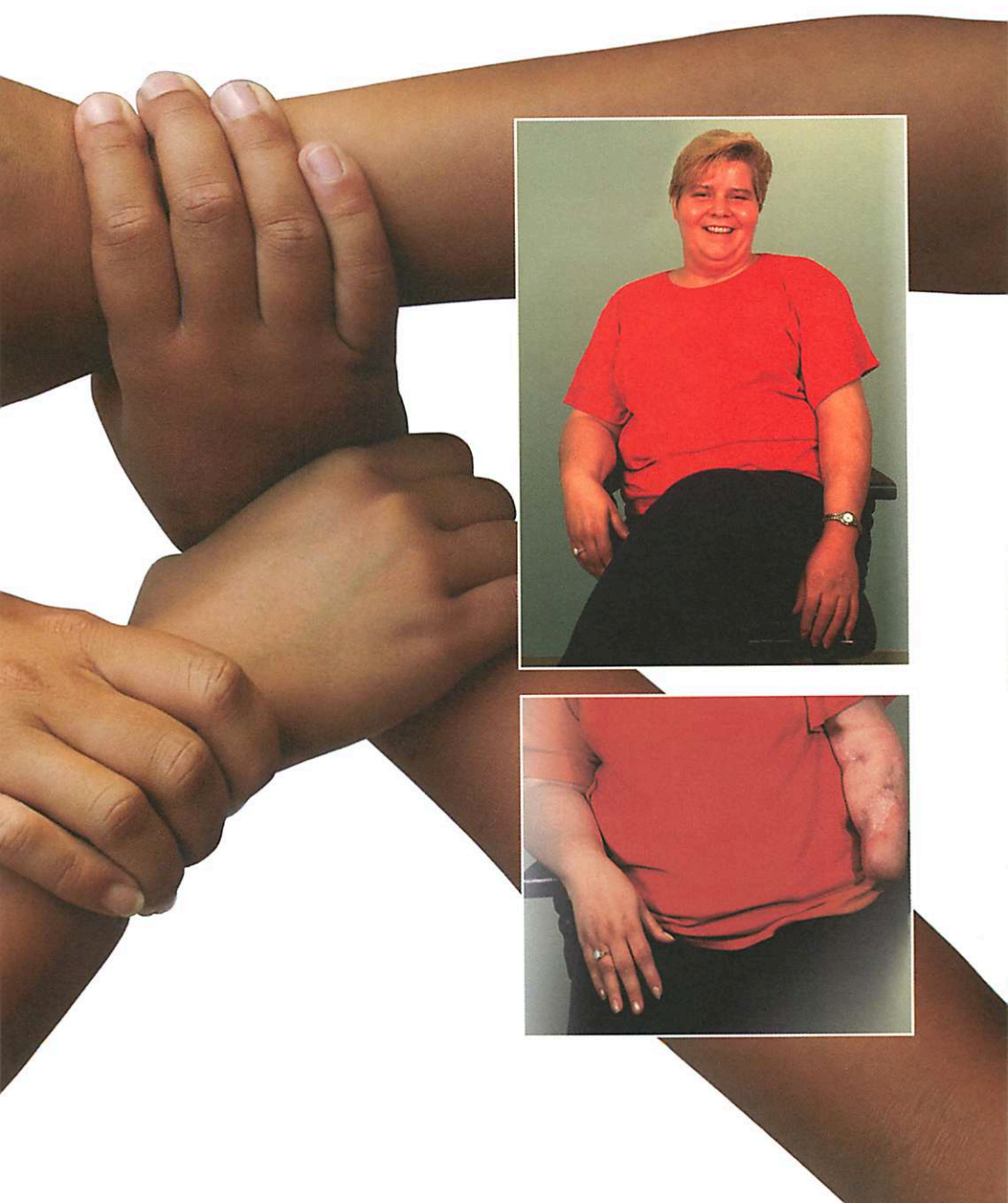

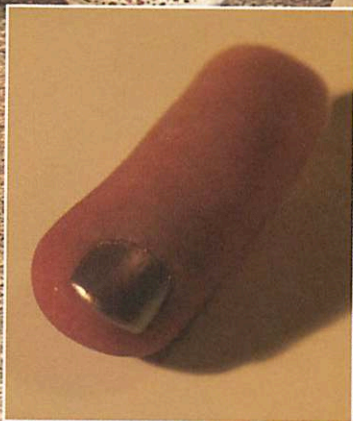
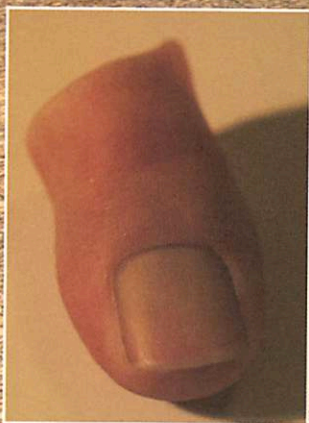
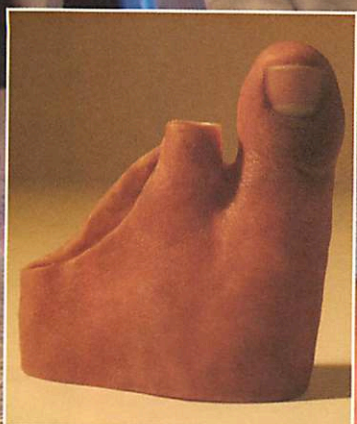

While clothing usually conceals most lower limb issues, LIVINGSKIN aesthetic restorations can provide a critical benefit when exposure is necessary or desirable, across a range of requirements. Various types of toe and partial foot prostheses can be created, attached in the similar way to those of the upper limbs but engineered for weight bearing needs.

Lower Limb Restoration

feet



unique

The i-LIMB Hand is the world's first, fully articulating bionic hand that delivers compliant grip, wraparound fingers, thumb movement and palmar grip. With this wide range of motion, it is critical to have a unique covering that is both durable and flexible at the same time.

Touch Bionics offers several different covering options for the i-LIMB Hand ranging from the high-tech i-LIMB Skin, to an off-the-shelf lifelike covering, to the fully customized LIVINGSKIN covering which can include nails, veins and freckles that match the sound hand perfectly.

i-LIMB Hand

e

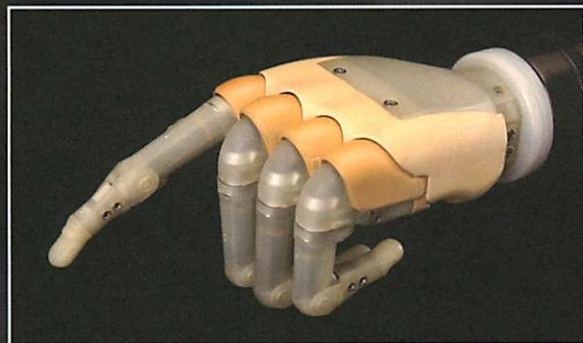
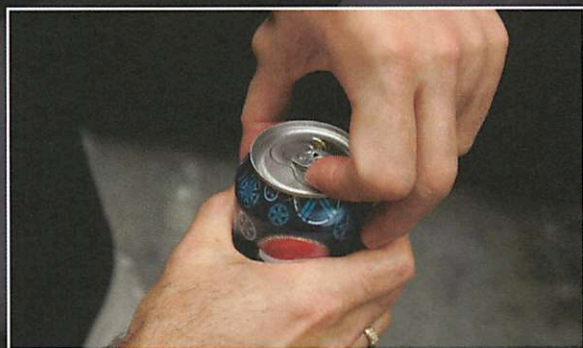
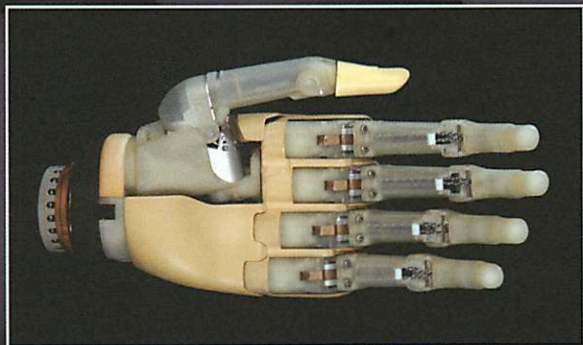

LIVINGSKIN FAQs

Q: How long after surgery must you wait before receiving a prosthesis?

A: Before pursuing a prosthesis, it is recommended that patients wait 3-6 months to ensure complete healing, and elimination of swelling prior to taking impressions. The authorization process can be started one month before impressions are taken.

Q: How long does it take to create a LIVINGSKIN prosthesis?

A: Fabrication of each custom silicone prosthesis is very labor-intensive. Most LIVINGSKIN prostheses take approximately 8-16 weeks to create. i-LIMB high definition covers are pre-fabricated and available upon request.

Q: How do the prostheses stay on?

A: Most LIVINGSKIN finger, hand, and foot prostheses are suspended by suction. When suction suspension is not possible, a combination of other methods are used.

Q: Do I need to use the donning lubricant each time I use the prosthesis?

A: Absolutely. For fingers, hands, toes and feet, not only does the water-based lubricant aid in providing suction for suspension, it also eliminates pulling and stretching of the silicone, avoiding tearing. Prostheses such as maxillofacial, and above and below elbow devices, do not require the use of a lubricant.

Q: Can the prostheses be worn all the time?

A: LIVINGSKIN users do not wear their prostheses when bathing, sleeping, or during activities that will be more strenuous on the silicone prosthesis. This includes activities such as guitar playing, sports, construction and auto maintenance. It is important to avoid oil-based products. Many hair and body products contain oils and should only be applied when not wearing the prosthesis.

Q: Is it just a cosmetic prosthesis?

A: Absolutely not. The level of function varies with each prosthesis depending upon the type of device. All LIVINGSKIN prostheses can perform non-manipulative activities, such as supporting, stabilizing, pushing and pulling. Finger prostheses can be used for activities such as typing and playing the piano.

Q: Do the fingers move?

A: This depends on the level of restoration. For example, if a finger prosthesis is made to replace just the tip of a finger or fingers, they can easily move and perform tasks. If the fingers are missing completely, then movement is limited. In some cases, an internal armature is inserted that can be bent into a desired position. With a body powered or myoelectric prosthesis, such as the i-LIMB, the LIVINGSKIN covering can move along with the prosthetic hand.

Q: Can the color be changed or modified?

A: Once painted, the color of the prosthesis can be darkened, using SeasonGuard the proprietary pigmentizer, which fades over time, as would a normal "tan". Customers are advised to have their prosthesis painted when they are not tanned. The color cannot be made lighter.

Q: Can fingernails be shaped and painted?

A: Depending on which LIVINGSKIN product you select, it may be possible to shape and paint your nails. You must use a NON-ACETONE nail polish remover.

Q: Can hair be incorporated into the prosthesis?

A: Yes, people with significant body hair can request DemaHair. Our custom matched, synthetic, non-removable hair, can be incorporated into their prosthesis. The DemaHair is embedded within the top layer of the LIVINGSKIN, therefore it cannot fall out or fade away. This feature must be specified prior to the manufacturing process.

Q: Will the prosthesis stain?

A: The silicone used to make a LIVINGSKIN prostheses is virtually stain proof. However, since there are many new chemicals and products that have not been tested, caution must be exercised when coming into contact with these materials. Some products to avoid are blue Woolite, carbon paper, unwashed jeans and certain leather tanning products.

Q: How long does a LIVINGSKIN prosthesis last?

A: The life expectancy of a LIVINGSKIN prosthesis depends on how it is used and maintained. With proper care and normal use, the average lifespan is 2 to 4 years.

Q: Is there a warranty?

A: Yes, each LIVINGSKIN prosthesis is covered by a 1-year repair or replacement warranty when proper and adequate care is given to the prosthesis. A 2-year repair and replacement warranty applies when a duplicate device is provided at the same time, and the devices are worn alternately to avoid excessive wear. All higher-level prostheses such as below elbow, above elbow and below knee, are covered by a 1-year warranty.

Q: What should I do if I tear or damage my prosthesis?

A: Never attempt to glue or repair the prosthesis yourself. Please call your local practitioner before sending the prosthesis back for repair.

Q: Are LIVINGSKIN prostheses paid for by insurance?

A: Yes, many insurance companies and Workers Compensation Boards pay for LIVINGSKIN prostheses. Touch Bionics administrative staff can help with these issues.

PREGUNTAS FRECUENTES SOBRE LIVINGSKIN

P: ¿Cuánto debe esperar después de la operación quirúrgica antes de recibir una prótesis?

R: Antes de proceder a utilizar una prótesis, se recomienda que los pacientes aguarden entre 3 y 6 meses para asegurar una curación completa y que se quite la hinchazón antes de tomar impresiones. El proceso de autorización se puede iniciar un mes después de haber recibido las impresiones.

P: ¿Cuánto tiempo lleva producir una prótesis LIVINGSKIN?

R: La fabricación de cada prótesis de silicona personalizada es muy laboriosa. Se tarda entre 8 y 16 semanas aproximadamente en producir la mayoría de las prótesis LIVINGSKIN. Las fundas protésicas i-LIMB de alta definición se prefabrican y están disponibles mediante solicitud.

P: ¿Cómo permanecen puestas las prótesis?

R: La mayor parte de las prótesis de dedos, manos y pies LIVINGSKIN se suspenden por succión. En los casos en que no resulta posible la suspensión por succión, se utiliza una combinación de otros métodos.

P: ¿Necesito utilizar el lubricante de aplicación cada vez que me pongo la prótesis?

R: Definitivamente. Para dedos, manos, dedos de los pies y pies, el lubricante con base de agua no sólo ayuda a proporcionar succión para la suspensión sino que también elimina la tirantez y el estiramiento de la silicona, evitando las rasgaduras. Las prótesis como la máxilofacial, así como los dispositivos encima y debajo del codo, no requieren el uso de lubricante.

P: ¿Se puede llevar puesta la prótesis en todo momento?

R: Los usuarios de LIVINGSKIN no llevan puesta la prótesis cuando se bañan, duermen o durante actividades que sean más arduas. Estas actividades incluyen tocar la guitarra, deportes, construcción y mantenimiento de coches. Es importante evitar productos con base de aceite. Muchos productos para el cabello y el cuerpo contienen aceites que sólo se deberían aplicar cuando no se tenga puesta la prótesis.

P: ¿Se trata de una prótesis cosmética solamente?

R: Definitivamente no. El nivel de funcionalidad varía con cada prótesis, en función del tipo de dispositivo. Todas las prótesis LIVINGSKIN pueden ejecutar actividades no manipuladoras, como sostener, equilibrar, empujar y tirar. Las próstas de dedos se pueden utilizar para actividades como teclear y tocar el piano.

P: ¿Se mueven los dedos?

R: Esto depende del nivel de restauración. Por ejemplo, si se hace una prótesis de dedo para reemplazar solamente la punta de uno o más dedos, éstos se podrán mover fácilmente y realizar tareas. Si falta la totalidad del dedo, entonces el movimiento es limitado. En algunos casos se inserta un armazón interno que se puede doblar a una posición deseada. Con una prótesis accionada por el cuerpo o mioeléctrica, como la i-LIMB, la funda protésica LIVINGSKIN se puede mover conjuntamente a la mano protésica.

P: ¿Se puede cambiar o modificar el color?

R: Una vez pintado, el color de la prótesis se puede oscurecer utilizando el pigmentador de marca SeasonGuard, que pasado el tiempo se desvanece, igual que un "bronceado" normal. Se aconseja a los clientes que pinten la prótesis cuando no estén morenos. El color no se puede aclarar.

P: ¿Se puede dar forma a las uñas con la lima y pintarlas?

R: Dependiendo del producto LivingSkin que se seleccione, puede ser posible dar forma con la lima y pintar las uñas. Se debe utilizar un quitaesmalte de uñas que NO TENGA ACETONA.

P: ¿Se puede incorporar pelo a la prótesis?

R: Sí, las personas que tengan mucho pelo corporal pueden solicitar DemaHair. Nuestro pelo sintético no removible y personalizado se puede incorporar a la prótesis. El DemaHair se incrusta en la capa superior del LIVINGSKIN, por lo que no puede caerse ni desvanecerse. Esta característica se debe especificar antes del proceso de fabricación.

P: ¿Se mancha la prótesis?

R: La silicona utilizada para hacer una prótesis LIVINGSKIN es prácticamente a prueba de manchas. No obstante y dado que hay muchos químicos y productos nuevos que no se han probado todavía, se deberá tener cuidado cuando la prótesis entre en contacto con estos materiales. Algunos de los productos que se deben evitar son Woolite azul [azulete de lavandería], papel carbón, vaqueros no lavados y ciertos productos de teñir piel.

P: ¿Cuánto tiempo dura una prótesis LIVINGSKIN?

R: El tiempo de vida útil de una prótesis LIVINGSKIN depende de cómo se utilice y mantenga. Con unos cuidados apropiados y un uso normal, el tiempo de duración medio es de 2 a 4 años.

P: ¿Hay garantía?

R: Sí, todos los productos LIVINGSKIN tienen 1 año de garantía de reparación o sustitución cuando se ha cuidado adecuadamente la prótesis. Se aplica una garantía de reparación o sustitución de 2 años cuando se suministra un dispositivo duplicado al mismo tiempo y los dispositivos se utilizan de manera alterna para evitar el desgaste excesivo. Todas las prótesis de nivel elevado, como las de debajo del codo, encima del codo y debajo de la rodilla, tienen una garantía de 1 año.

P: ¿Qué debería hacer si mi prótesis se desgarró o dañó?

R: Nunca deberá intentar pegar o reparar la prótesis usted mismo. Rogamos que se ponga en contacto con el profesional local antes de enviarnos la prótesis a reparar.

P: ¿Paga el seguro la prótesis LIVINGSKIN?

R: Sí, muchas compañías de seguros y juntas de compensación obrera pagan prótesis LIVINGSKIN. El personal administrativo de Touch Bionics puede ayudar en estas cuestiones.

North American Customers (Canada, Mexico & US)

Tel: +1-800-208-SKIN (7546)

Tel: +1-845-346-4225

UK & Non-North American Customers

Tel: +44 1506 438 556

Email: info@touchbionics.com

For address details and further information please visit our website:

Website: www.touchbionics.com

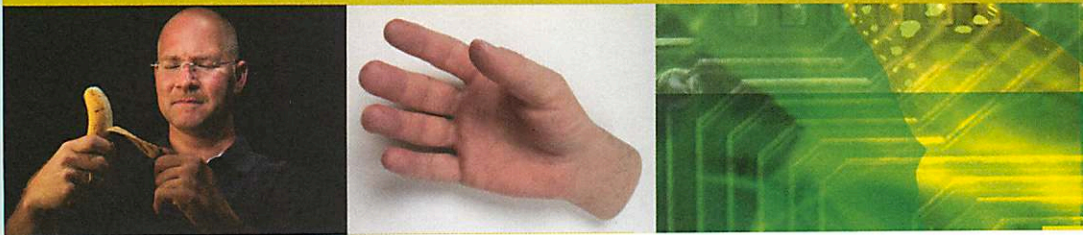

Touch Bionics™, LIVINGSKIN™, DermaHair™, i-LIMB™ Hand, SeasonGuard™, i-LIMB™ and ProDigits™ and associated logos are trademarks of Touch EMAS Limited and/or are the subject of trademark applications or registrations in various countries around the world. All Touch EMAS products are subject to continuous research and development – we therefore reserve the right to alter technical specifications without prior notice. Touch EMAS products are protected by patent and/or patent applications in various countries around the world.

© Copyright 2009 Touch Bionics Inc. and Touch EMAS
All rights reserved.
Part number: 066057A

TOUCH BIONICS™

Transforming the Everyday Lives
of Extraordinary People



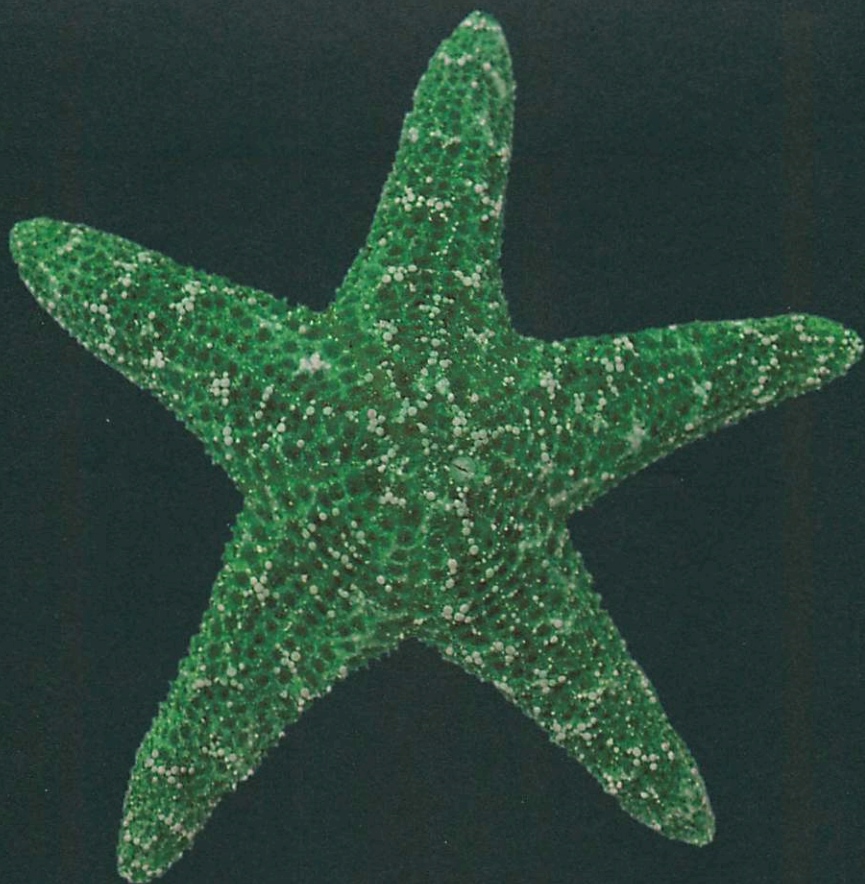

PRODIGITS™

The Partial Hand Solution

Powered replacement fingers.

challenging



Not having fingers or a thumb to act in opposition to one another makes simple tasks such as holding a fork or a cup difficult and frustrating. Thanks to ProDigits, an expertly built prosthesis rebuilds function and confidence.

Each individually powered ProDigit provides myoelectric control that has never been possible before. Now patients or users with between 1-5 missing fingers have a solution for what was once a highly debilitating condition.

Partial Hand



There are physical criteria that dictate whether ProDigits are appropriate or not – candidates must have 'Amputation at Transmetacarpal Level' or higher of one or more fingers. It is possible to support candidates with a portion of the finger remaining, however, this does affect the aesthetics of the overall prosthesis.

Figure illustrates level of hand absence with diagram of prosthesis with ProDigit mounted to provide hand function utilizing remaining thumb as active opposition post.

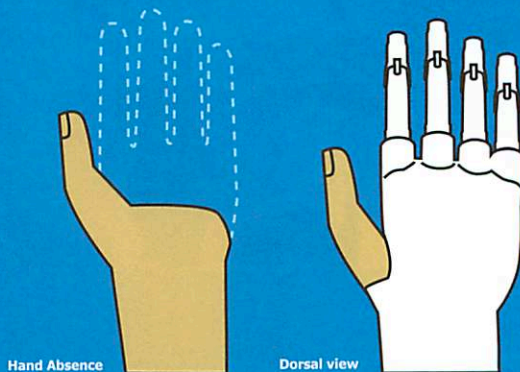

solution



Prosthesis Build



n

The modular nature of each ProDigit and the individually powered motor located within each digit means that the clinician can build a replacement prosthesis that is close to the patient or users missing anatomy. Solutions can be built to match the sound side or any remaining fingers.

Thumb solutions can be built using either powered or non-powered options. Sockets are custom-designed and fabricated for each individual's needs.



technology

Take Control

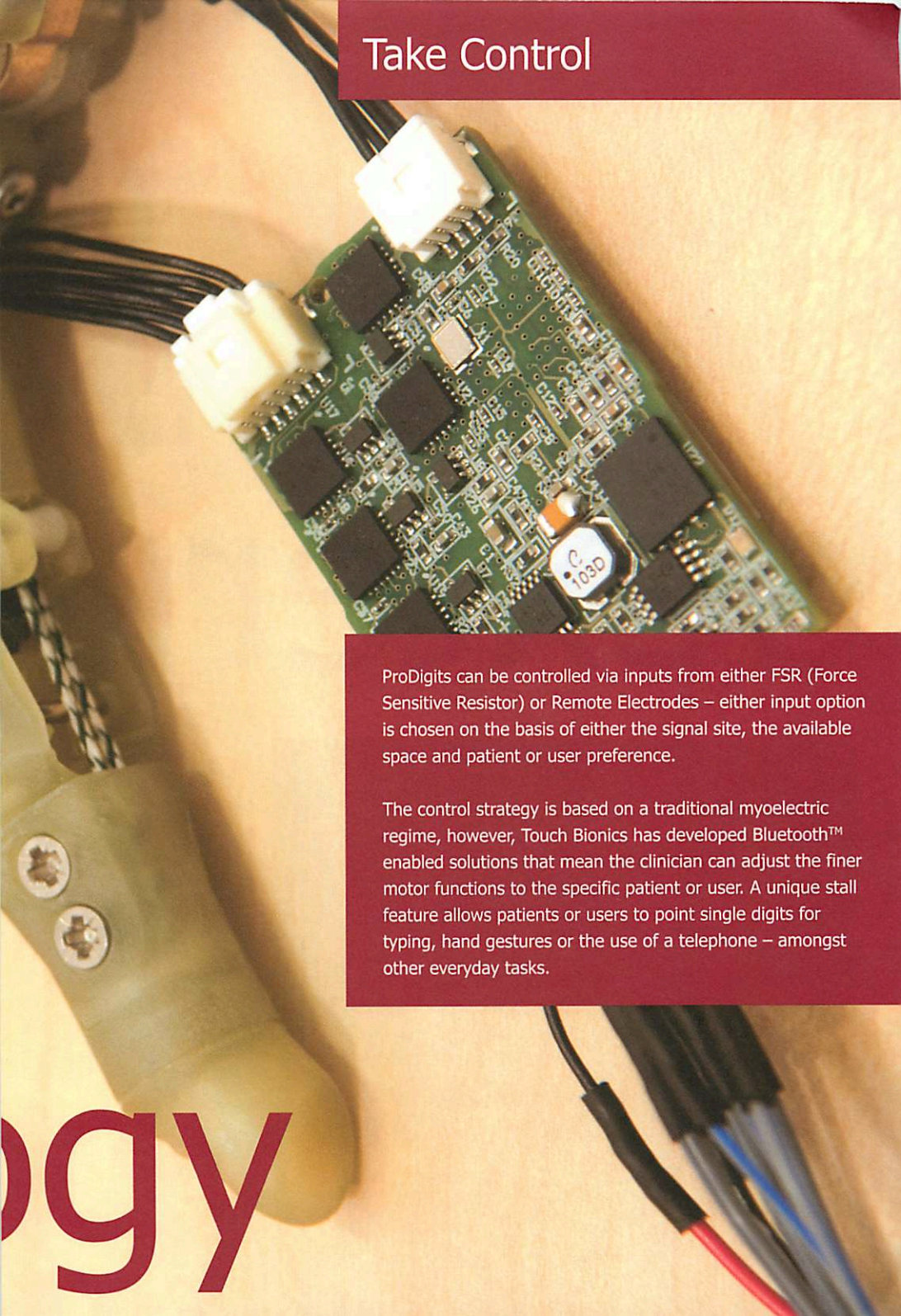

ProDigits can be controlled via inputs from either FSR (Force Sensitive Resistor) or Remote Electrodes – either input option is chosen on the basis of either the signal site, the available space and patient or user preference.

The control strategy is based on a traditional myoelectric regime, however, Touch Bionics has developed Bluetooth™ enabled solutions that mean the clinician can adjust the finer motor functions to the specific patient or user. A unique stall feature allows patients or users to point single digits for typing, hand gestures or the use of a telephone – amongst other everyday tasks.

ogy

TOUCH



dexterity

Through the versatile construction of the ProDigit, prosthetists and healthcare professionals are now able to construct partial hand solutions that are both anatomically accurate and life changing.

Touch Bionics' development team has created a choice of two innovative prosthesis coverings, both of which set new industry benchmarks and meet specific usage objectives. Covering options protect the hand from moisture and dust and include high-tech clear skins through to natural skin shades. Subtle highlights on the knuckles and palmar surface, and color defined fingernail tips, give an enhanced, natural appearance.



Form & Function



With wide interest and patient or user demand for ProDigits, growing numbers of clinical professionals have been trained to meet the demand for pre-fitting assessment, support and aftercare.

Accredited Clinical Collaborator status reflects an investment in learning the finer points of ProDigits. Trained Clinical Collaborators cover every aspect of the detail required to support patients or users – from patient selection, reimbursement, to servicing, support and aftercare.

The contact details of all Accredited Clinical Collaborators can be found at www.touchbionics.com



profe



Touch Bionics Clinical Collaborator

This is to certify that:

Diana Smith

of

ABC Partners

is certified by the Directors of Touch Bionics as a
Touch Bionics Clinical Collaborator

Effective until:

17th March 2010



Chief Executive Officer

TOUCH-BIONICS
Transforming the Everyday Lives
of Extraordinary People



Professionals

North American Customers (Canada, Mexico & US)

Tel: +1-800-208-SKIN (7546)

Tel: +1-845-346-4225

UK & Non-North American Customers

Tel: +44 1506 438 556

Email: info@touchbionics.com

For address details and further information please visit our website:

Website: www.touchbionics.com



Touch Bionics™, LIVINGSKIN™, DermaHair™, i-LIMB™ Hand, SeasonGuard™, i-LIMB™ and ProDigits™ and associated logos are trademarks of Touch EMAS Limited and/or are the subject of trademark applications or registrations in various countries around the world. All Touch EMAS products are subject to continuous research and development – we therefore reserve the right to alter technical specifications without prior notice. Touch EMAS products are protected by patent and/or patent applications in various countries around the world.

© Copyright 2009 Touch Bionics Inc. and Touch EMAS Ltd. All rights reserved.

Third-party product and brand names may be trademarks or registered trademarks of their respective owners.

Issue No. 1.0 May 2009 Part number: 069109A

TOUCH BIONICS™

Transforming the Everyday Lives
of Extraordinary People





PRODIGITS™

The Partial Hand Solution

Powered replacement fingers.

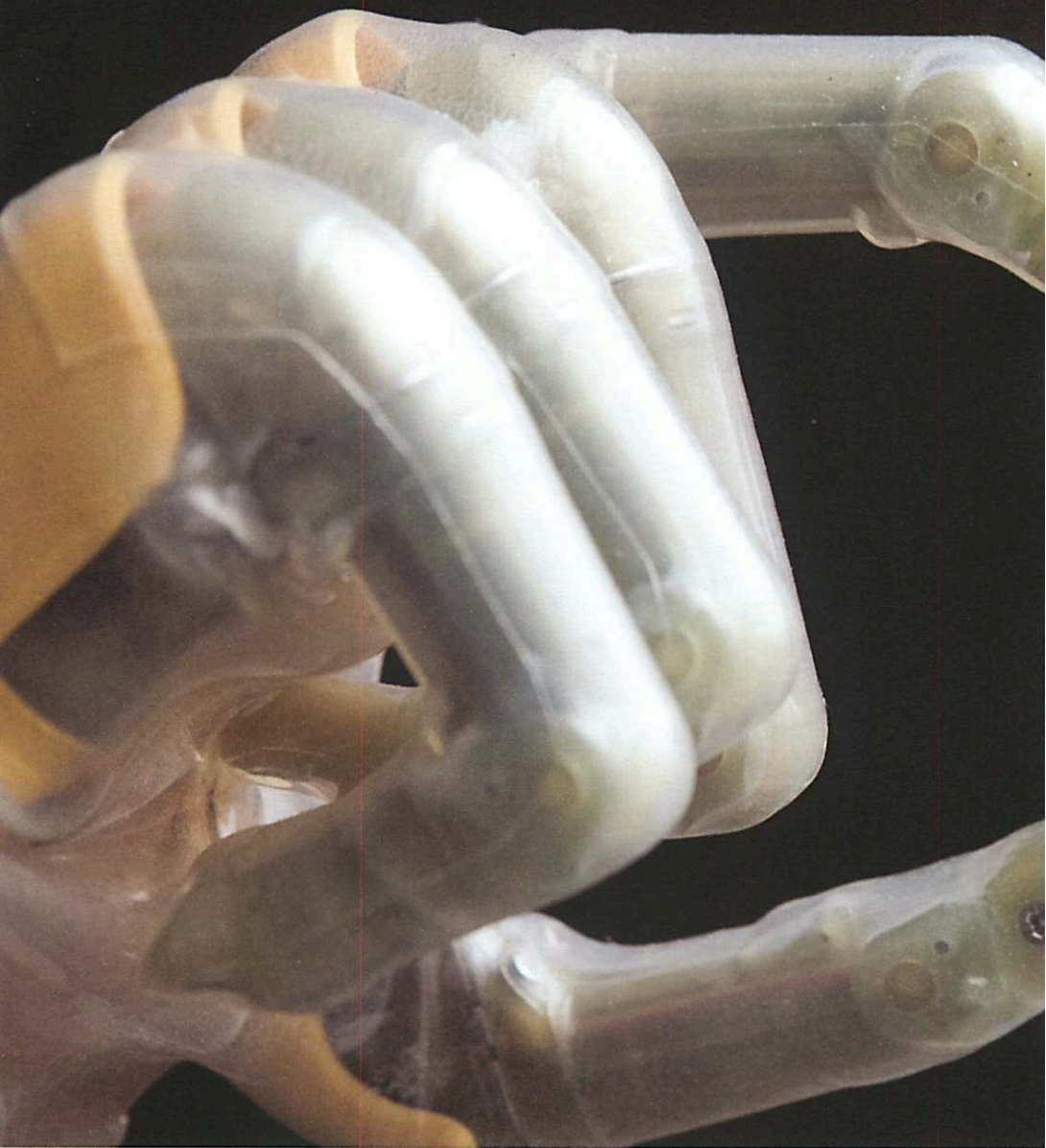



PRODIGITS™

The Partial Hand Solution

art!cultural

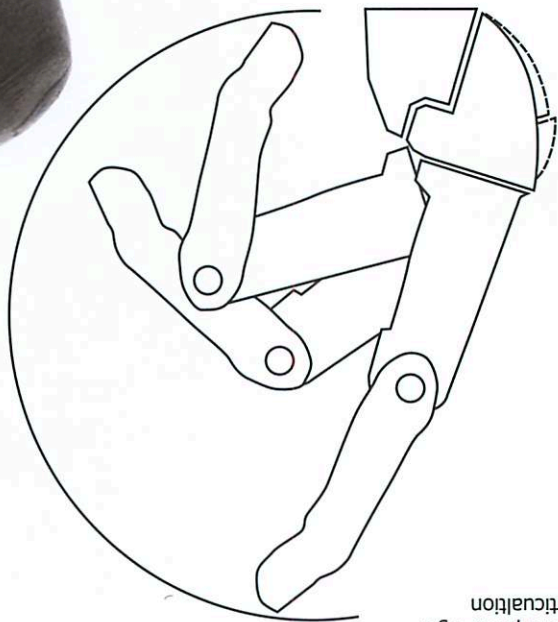
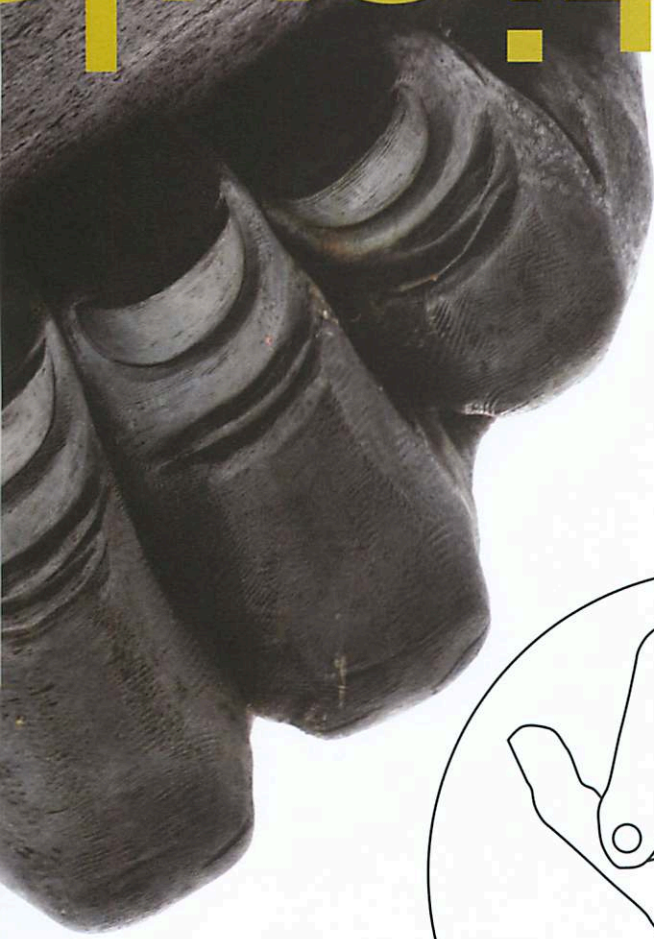

ProDigit™
multi-point digit
articulation

Articulating Digits

ProDigit componentry showing motor and gearbox mechanical configuration

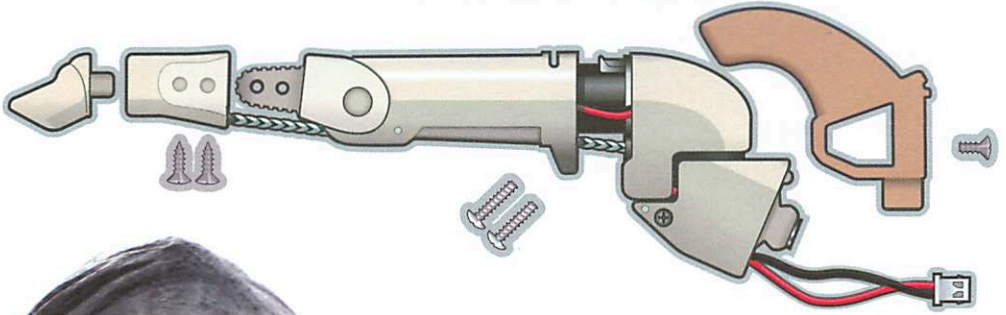

ProDigits refers to the articulating digits that underpin much of Touch Bionics' technical advantage. It is this articulation that provides the biggest benefit to the user.

With the ability to bend, grip and point, ProDigits can be used to develop a partial hand prostheses that more closely reflects the function of a natural hand. Before ProDigits, powered solutions were not an option for people with partial hands.

Now everything has changed for the partial hand community.

ation

challenging

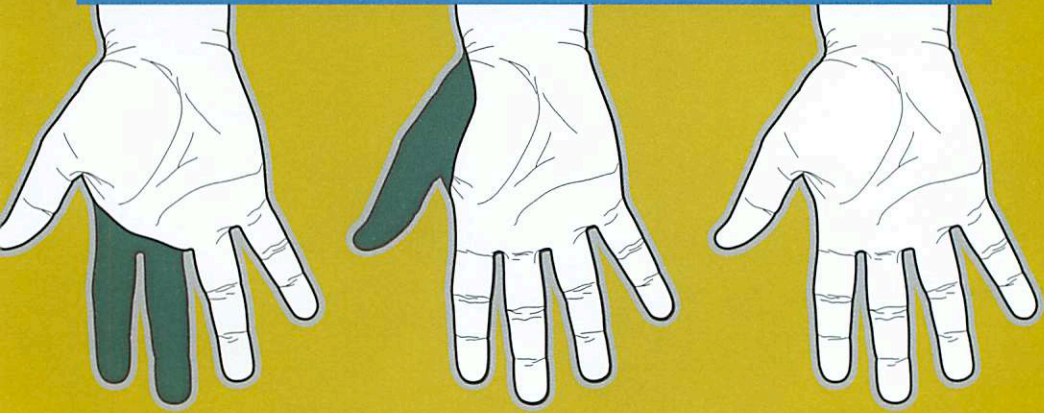

Not having fingers or a thumb to act in opposition to one another makes simple tasks such as holding a fork or a cup difficult and frustrating. Thanks to ProDigit, an expertly built prosthesis rebuilds function and confidence.

Each individually powered ProDigit provides myoelectric control that has never been possible before. Now users with between one and five missing digits have a solution for what is a highly debilitating condition.

Partial Hand

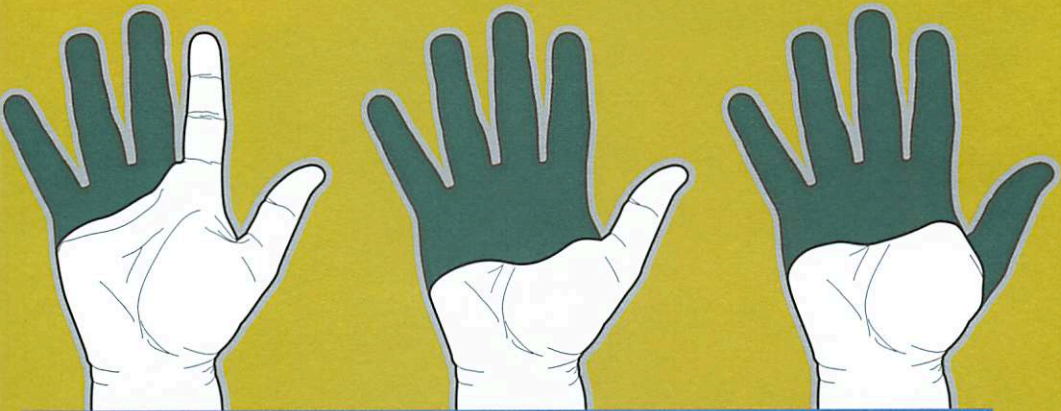

Certain physical criteria dictate whether ProDigits are appropriate or not – ideal candidates have digit absence at transmetacarpal level or higher of one or more fingers, although there are exceptions, and every candidate must be assessed by a qualified clinician before a decision on suitability for a ProDigits prosthesis can be made.

Figure illustrates level of hand absence with diagram of prosthesis with ProDigits mounted to provide hand function, utilizing the remaining thumb as an active opposition post.

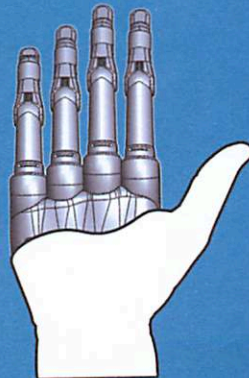

solutio



Prosthesis Build

n

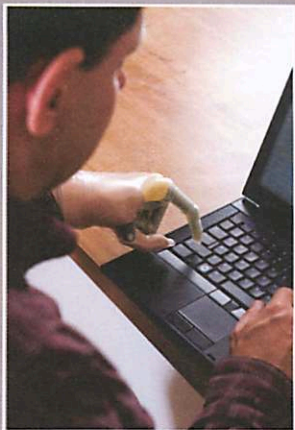

The modular nature of each ProDigit and the individual motor located within each digit means that the clinician can build a replacement prosthesis that is customised to meet the specific configuration of the affected hand.

Sockets are custom-designed and fabricated for each individual's needs. This ensures that the final prosthesis incorporates a user's remaining fingers, enabling them to work in conjunction with the ProDigits.

ProDigits devices can be built using either powered or non-powered options to replace missing thumbs, depending on the user's requirements.



technology

Take Control

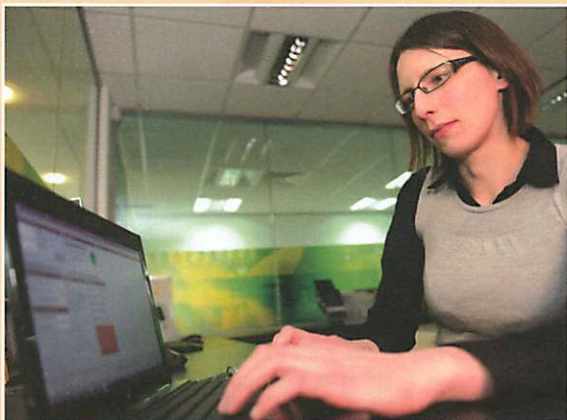

ProDigits can be controlled via inputs from either FSRs (Force Sensitive Resistors) or electrodes. The input option is chosen on the basis of the signal site location, the available space or the user's preference.

The control strategy is based on a traditional myoelectric regime, however, Touch Bionics has developed Bluetooth® enabled software called BioSim that allows the clinician to adjust the finer motor functions to the specific user. A unique stall feature allows patients or users to point single digits for typing, making hand gestures, using a telephone or other everyday tasks.

ogy

dexterity



Through the versatile construction of ProDigits, clinicians are now able to construct partial hand solutions that are both anatomically accurate and offer life-changing return to function.

For ProDigits solutions, Touch Bionics' development team has created a choice of two innovative prosthesis coverings, both of which set new industry benchmarks and meet specific usage objectives. These covering options protect the hand from moisture and dust and range from high-tech clear skins through to natural skin shades. Subtle highlights on the knuckles and palmar surface, and color-defined fingernail tips, give an enhanced, natural appearance.

Form & Function

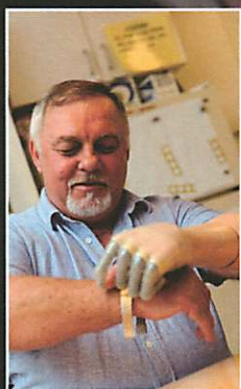

North American Customers (Canada, Mexico & US)

Tel: +1-800-208-SKIN (7546)

Tel: +1-614-388-8075

UK & Non-North American Customers

Tel: +44 1506 438 556

Email: info@touchbionics.com

For address details and further information please visit our website:

Website: www.touchbionics.com



Touch Bionics™, LIVINGSKIN™, DermaHair™, i-LIMB™ Hand, SeasonGuard™, i-LIMB™ and ProDigits™ and associated logos are trademarks of Touch EMAS Limited and/or are the subject of trademark applications or registrations in various countries around the world. All Touch EMAS products are subject to continuous research and development – we therefore reserve the right to alter technical specifications without prior notice. Touch EMAS products are protected by patent and/or patent applications in various countries around the world.

© Copyright 2010 Touch Bionics Inc. and Touch EMAS Ltd. All rights reserved.

Third-party product and brand names may be trademarks or registered trademarks of their respective owners.

Issue No. 2.0 April 2010 Part number: 069109A

TOUCH BIONICS™

Transforming the Everyday Lives
of Extraordinary People





TOUCH BIONICS™

Centre of Excellence



Prosthetic Care:
At the heart of our organisation

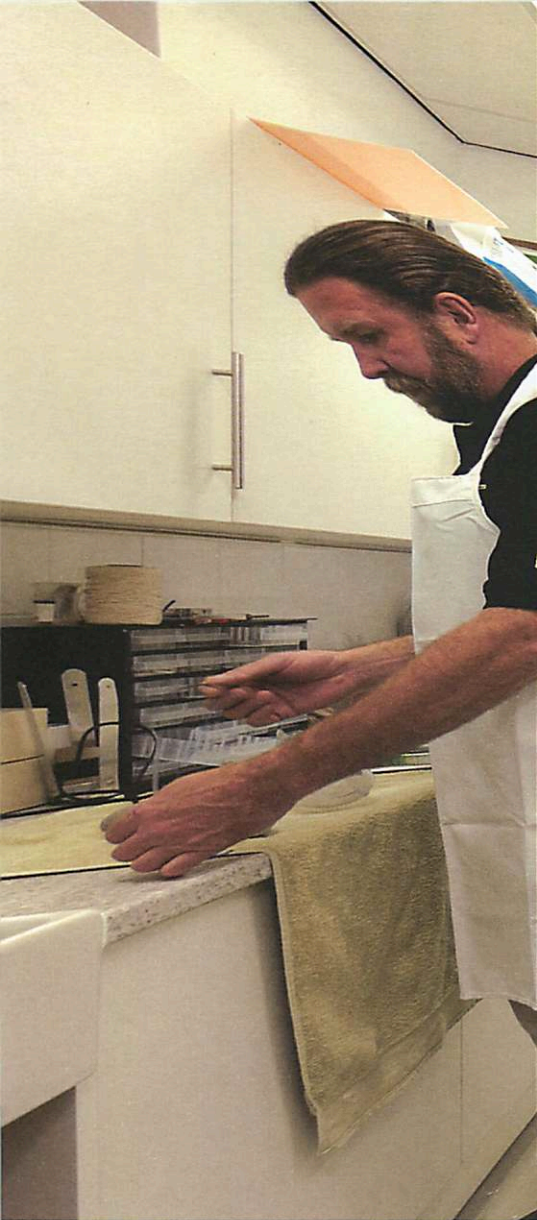

At the Touch Bionics Centre of Excellence in Livingston, Scotland, we put our clients at the heart of our organisation – with each case being reviewed and managed by both Touch Bionics' clinical and development teams. It is this interaction that sets our Centre of Excellence apart from many other types of clinical establishment – fast track access to the experts.

Touch Bionics Centre of Excellence offers a full clinical service to clients with upper limb absence. Our team of highly skilled professionals are on hand to help every step of the way.

Managed by the "Touch Life Total Care Programme", our service is tailored to each individual's needs and takes the full range of prosthetic solutions into account, from high tech solutions to simple devices for specific tasks.

The Centre of Excellence offers assessments, recommendations, insurance reimbursement support, fitting services and occupational therapy.

Our resident team of clinical and support staff are here to ensure that the appropriate technology is provided and that clients and their relatives and carers alike are well looked after in our specialist facility. A rehabilitation team is formed for each case and is responsible for the clinic's 'total care' approach.

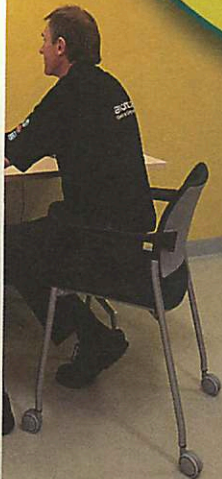
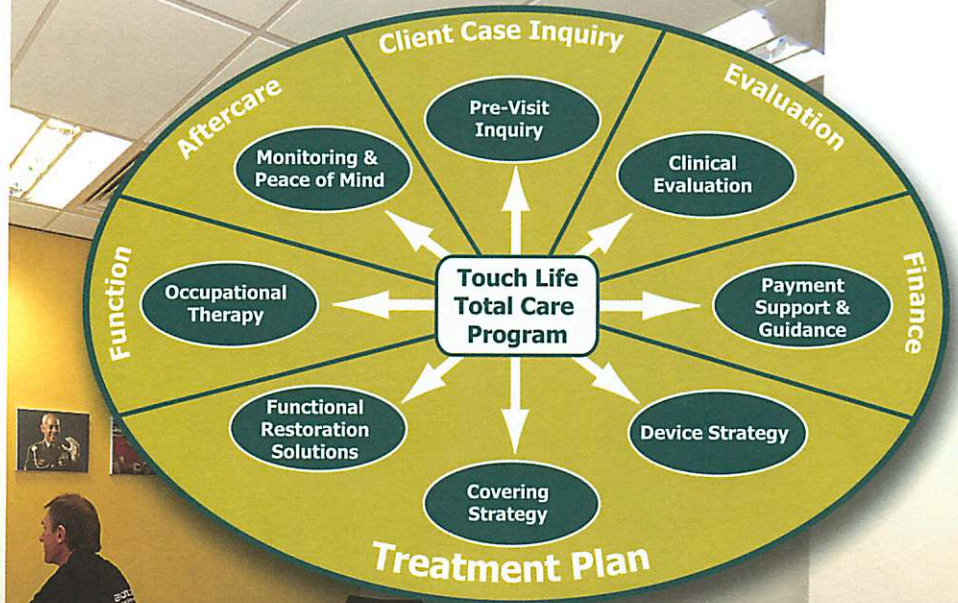

TOUCH BIONICS™
Centre of Excellence



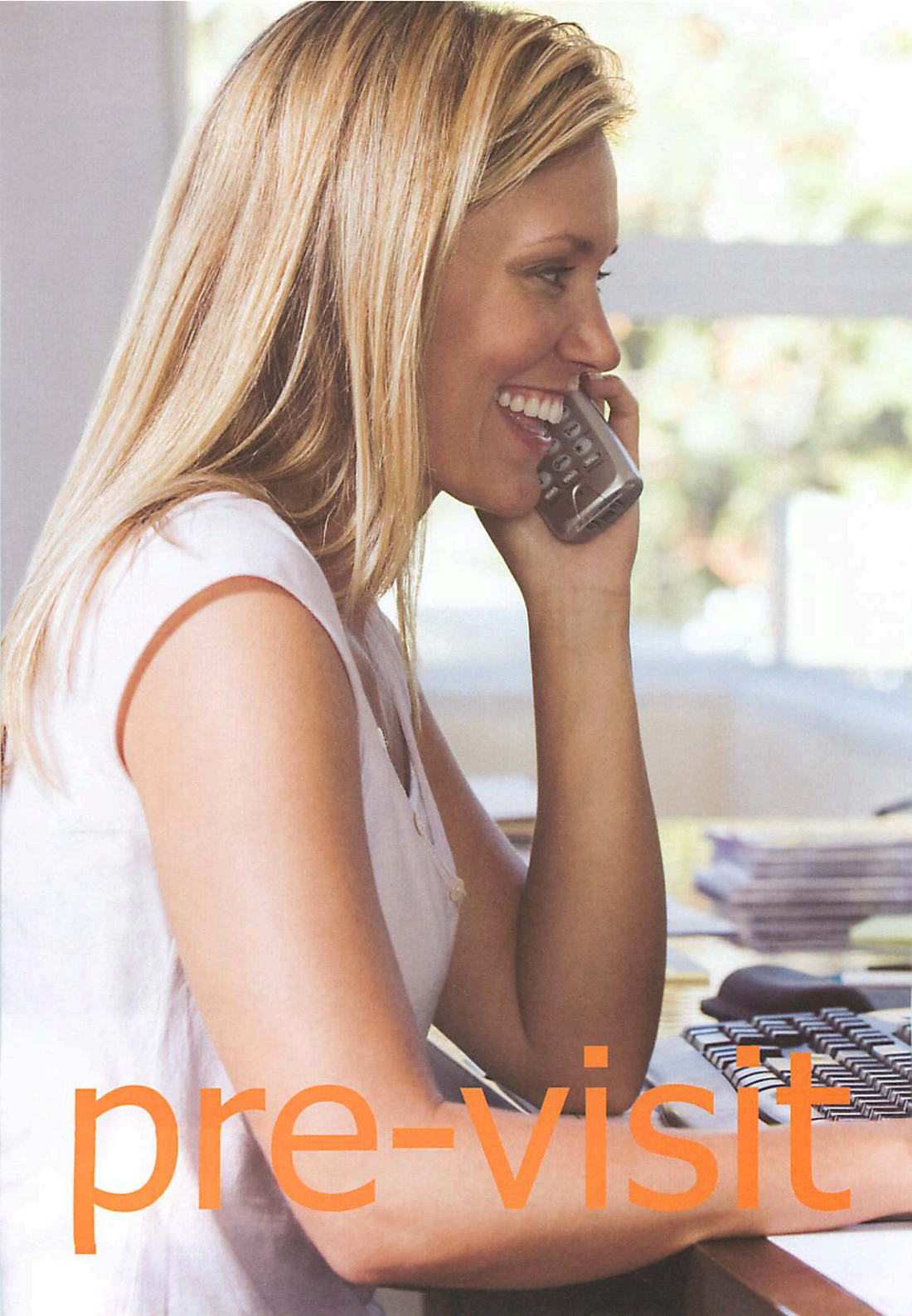

pre-visit

Client Case Enquiry

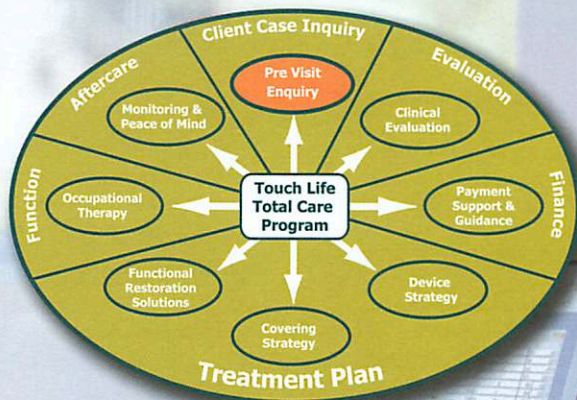

Before clients visit the Centre of Excellence, we will perform a remote case evaluation under the guidance of one of our in-house prosthetic experts. Our fact-finding process includes a review of case history, level of limb absence, occupation, hobbies and body type – at this stage we also request photographs.

During this phase we assess both the physical and financial aspects of the client's case before proceeding to a full clinical evaluation at our facility.

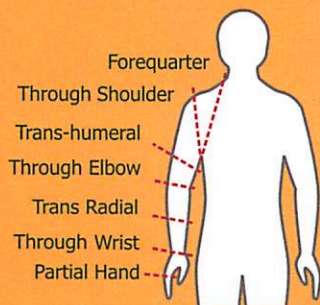

All of these are candidates for fitting at Touch Bionics' Centre of Excellence.

Our practitioners offer the highest level of professionalism and expertise. Clinical evaluation takes account of the client's current lifestyle and their expectations for life after fitting. Before we begin the Touch Life Total Care Programme, it is important to go through a thorough physical assessment. We work with the client and their family to better understand background information, day-to-day needs and goals for the future.

Physical Assessment

We recognise the importance of body image and we want to ensure that our clients have the very best personal and social experiences – this is why we consider the full scope of physical assessment such an important part of the Touch Life Total Care Programme.

Limb absence, whether congenital or as a result of amputation, encompasses a range of physical and psychosocial challenges, including alterations in body image and lifestyle, changes in self-perception, impairments in physical functioning, prosthesis use and pain.

eva



Evaluation

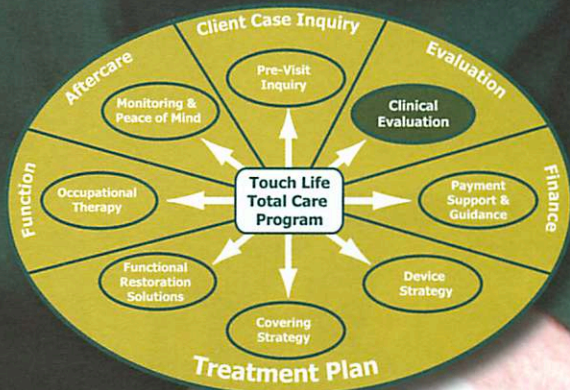

valuate

Touch Life Total Care Programme

Our extensive experience in upper extremity prosthetic care has taught us one fundamental – “No single prosthesis will address the multiple deficits associated with upper extremity limb loss”.

With this in mind, the focus of our comprehensive initial assessment is to first introduce the client to the technological solutions appropriate for their condition and subsequently to identify which system or combination of systems will return them to an optimal level of functional rehabilitation, whether at home, at work or at play.

The Touch Life Total Care Programme can provide solutions based on relatively simple functional aids, to more complex custom fitted electromechanical systems like ProDigits™ or products from Touch Bionics' i-LIMB™ Family. Particular attention is always paid to the appearance or “aesthetics” of the device/s.



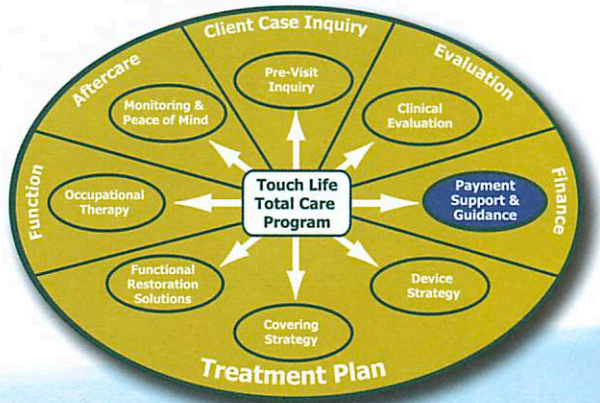

support

We understand that the solutions the Centre of Excellence creates for our clients may require careful management in securing financial investment from healthcare providers and insurers. Therefore a key part of the Touch Life Total Care Programme is providing the support required to build a sound clinical case for the client and the professionals they will encounter.

Our administrative team supports the client and their family in their engagements with payment providers such as insurance companies, national health system providers and personal injury experts. We can provide documentation to help explain why the Touch Life Total Care Programme is appropriate for their case, and provide a solid justification for obtaining payment authorisation. We are there with our clients every step of the way – including support for appeals, if required.

i-LIMB Hand, i-LIMB Pulse and Other External Powered Devices

With fully articulating fingers and a rotatable thumb, the i-LIMB Hand was the first myoelectric hand to deliver a fully compliant grip. The latest addition to the i-LIMB Family is the i-LIMB Pulse, a new version of the hand designed with an aluminium chassis for increased robustness, and new software-enabled grip patterns for improved functionality.

These products bring a new dimension to upper limb prosthetics, providing levels of flexibility, durability, aesthetic presentation and overall functionality that have never been seen before.

The combination of mechanical function, myoelectric control and cosmesis provide a new definition of grip. Simple, natural actions such as grasping, pinching, twisting and pointing are now possible thanks to the i-LIMB products.

However, at the Centre of Excellence we also recognise that other types of devices are appealing to users – this is why we also offer primary and secondary myoelectric devices for users – to benefit from a prosthetic device strategy that is tailored specifically to each client's preferences for dexterity and aesthetics, as well as work, recreational and functional needs.



i-LIMB PULSE

i-LIMB™ HAND

Get a Grip on Functionality

Treatment Plan

Device Strategy

Full Hand

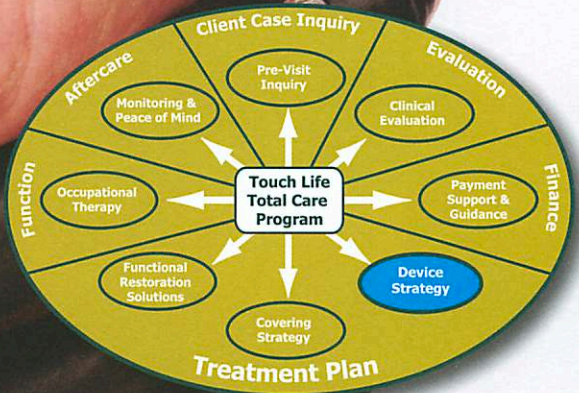

hands



ProDigits – the Partial Hand Solution

In another industry first, the ProDigits finger technology that underpins the i-LIMB Hand has been adapted for clients who have a partial hand requirement, due to either congenital finger absence or fingers lost through amputation.

Not having fingers or a thumb to act in opposition to one another makes simple tasks such as holding a fork or a cup difficult and frustrating. Prior to ProDigits, the only option for people with partial hands were passive fingers, which provide an aesthetic solution and partial grip function, but have limited value in performing activities of daily living.

A ProDigits partial hand solution can help provide a return to function for the many individuals who so far have had no effective powered options available to them.



PRODIGITS™

The Partial Hand Solution

Device Strategy

Partial Hand

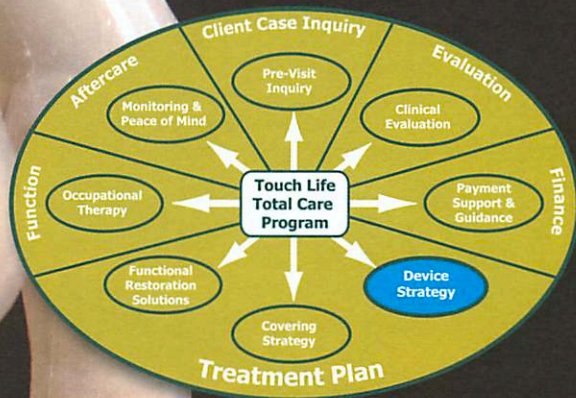

partial hand

Hybrid or Special Use

The Centre of Excellence also offers a variety of specialist devices from our affiliates.

This includes a range of sports and recreation solutions for activities including aerobics, basketball, swimming, fishing and golfing.

We also offer special use components to help people become more independent in their everyday lives. A range of tools and utensils are available, such as carpentry and mechanic tools, gardening, cutlery and eating utensils.

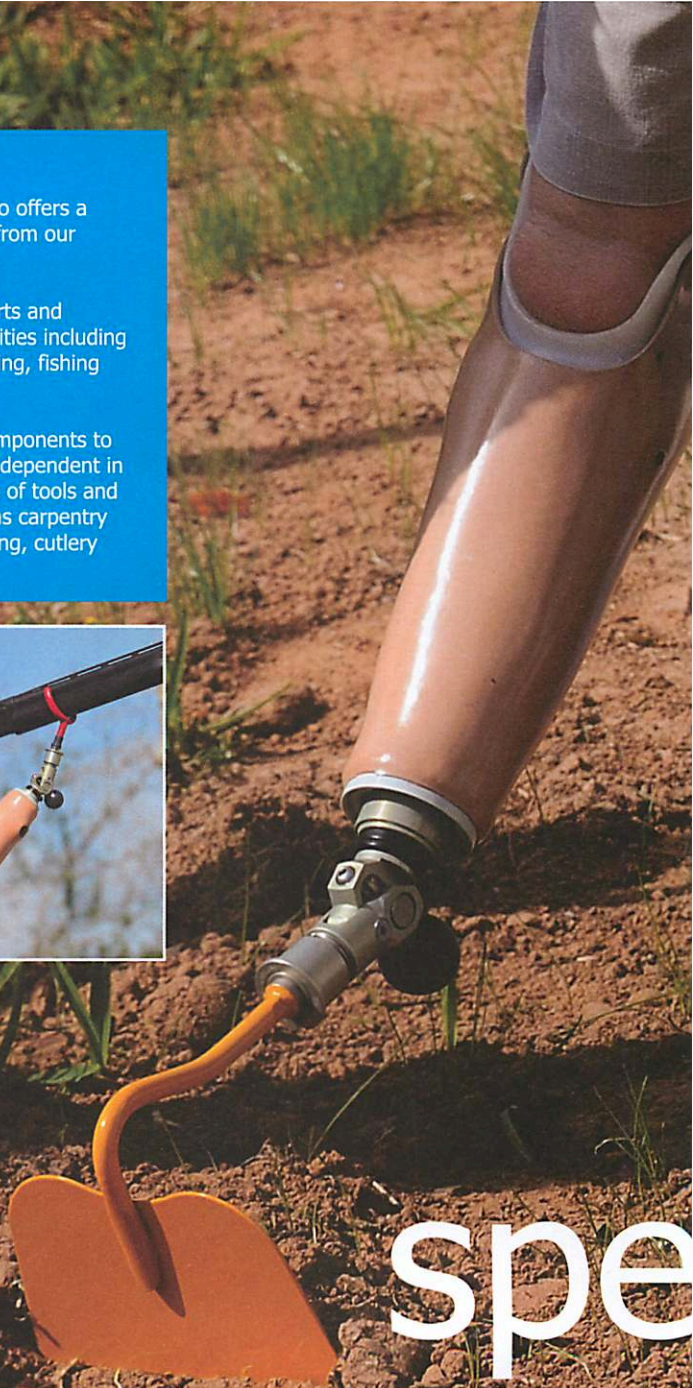

spe

Treatment Plan

Device Strategy

Special Use

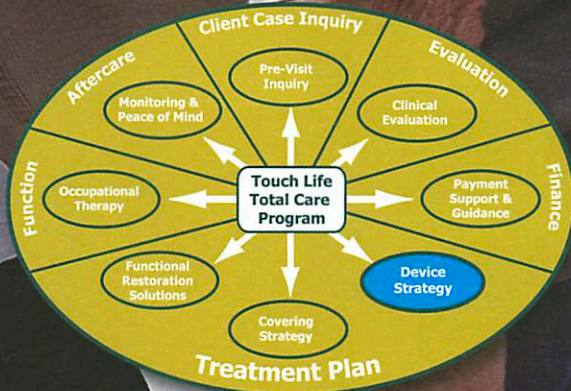

cial use





i-LIMB Skin

Some patients love the high-tech appearance of the uncovered i-LIMB Hand and i-LIMB Pulse, and for these people Touch Bionics developed the i-LIMB Skin. It's a thin layer of high-flex material, computer-modelled to fit every contour of the hand with a unique internal slip-coating to aid movement. i-LIMB Skin allows free movement of the fingers and rotating thumb, while protecting the hand from moisture and dust – it provides a highly effective grip surface.

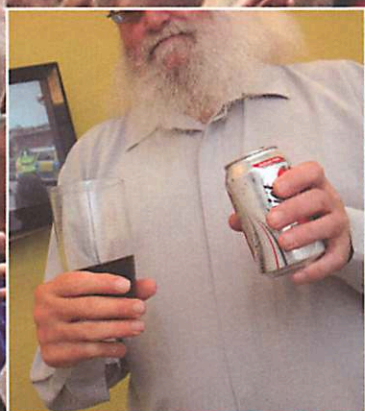

Off-the-Shelf Coverings

Developed from a unique, custom blended silicone, Touch Bionics' Dynamic Flex covering is available off-the-shelf and moves flexibly with the i-LIMB Hand's four articulating fingers and rotating thumb to give the combined benefits of advanced function and aesthetic accuracy.

These coverings come in a choice of 10 skin shades, with subtle highlights on the knuckles and palmar surface and colour defined fingernail tips, giving an enhanced, natural appearance.

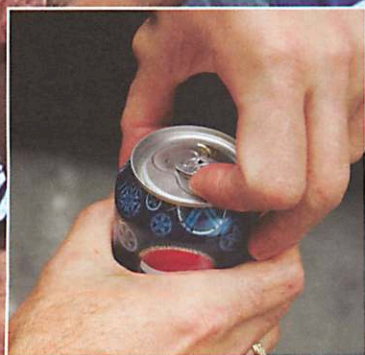

LIVINGSKIN™ fully customised

A fully customised LIVINGSKIN high-definition silicone cover for either a myoelectric or body powered device is created to resemble human skin by mimicking the three dermal layers of natural human skin. To ensure proper colour matching and fit, every covering is custom crafted for each individual – almost every detail can be catered for. An off-the-shelf high definition covering is also available, which is hand painted and available in 10 different skin shades.

Covering Strategy

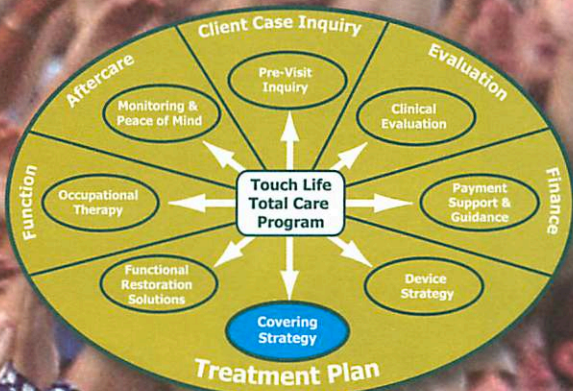

choice

Functional Restoration Solutions

The role of aesthetics in the field of prosthetics is extremely important and plays a key factor in addressing the combined functional and psychosocial deficits experienced by individuals with limb absence.

LIVINGSKIN functional restoration solutions are aesthetically accurate creations that help to deliver the appearance of normality, at every level of interaction. The detail work that Touch Bionics puts into every creation blends so closely with the client's natural skin, in tone, colour and texture that the distinction is virtually unnoticeable. Tiny surface anomalies, moles, freckles, cuticle variations and even tattoos – everything is possible.



For added realism, DermaHair™ can be added to any LIVINGSKIN solution. Duplicating a client's natural hair patterns, DermaHair doesn't fade or fall out.

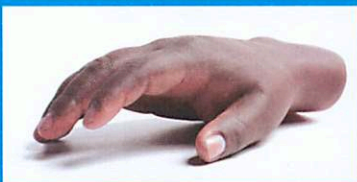

LIVINGSKIN™

Functional Aesthetic Restoration



res

Functional Restoration Solutions

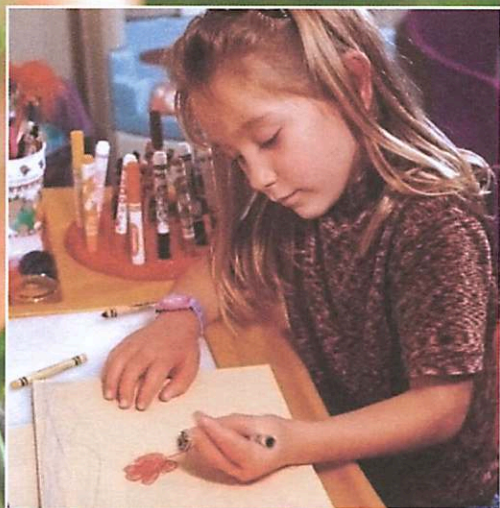
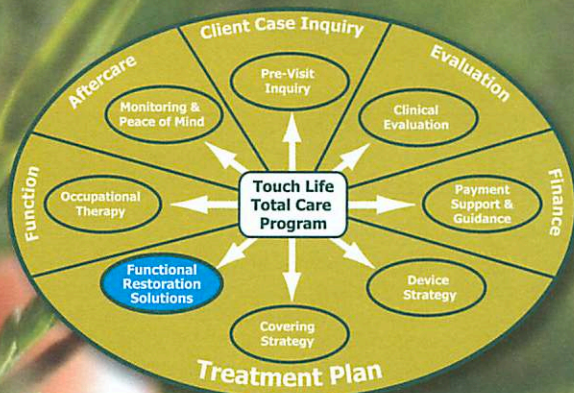

store

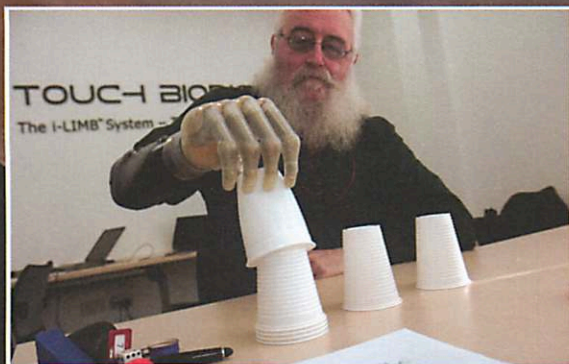

Independence in all functional activities is the goal of every person with upper limb absence, and the occupational therapists at the Centre of Excellence play a key role in helping provide a return to independence. Every client with upper extremity limb absence is unique and we base our occupational therapy on our client's individual needs and preferences.

In the assessment stage, we listen to our client's interest areas and future goals and incorporate them in our treatment programme. We make every effort to engage with the occupational therapists in the client's home community and provide support after new technology is introduced and the aftercare continued locally. As part of our Total Care Programme, the client can expect regular follow-ups from our own therapists, ensuring that they make the most out of their prosthetic devices.

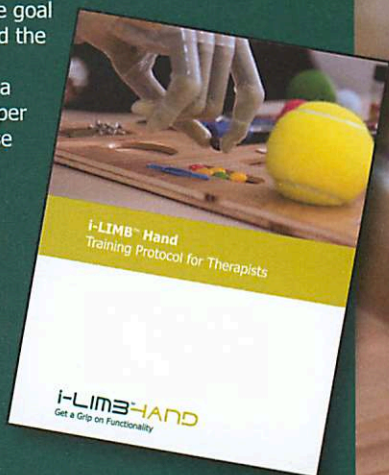

occupation

Function

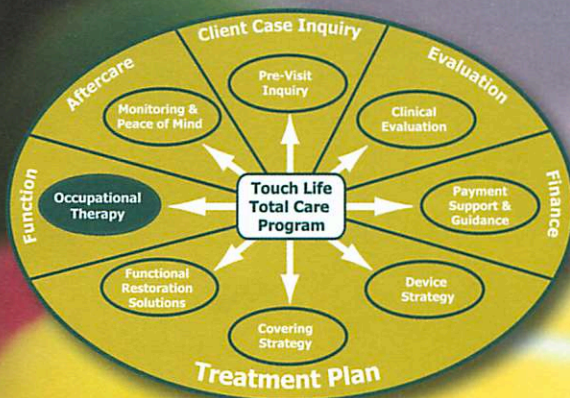

al therapy



peace of

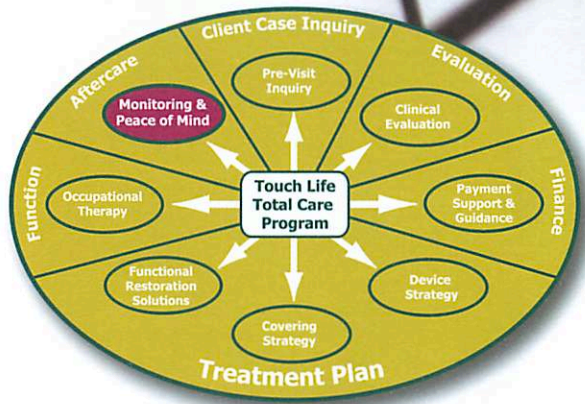

mind

Monitoring

After they leave the Centre of Excellence, we want to ensure that our clients are making the most of their prostheses and getting the most out of life. For this reason, we stay in touch with the client and the Physical Medicine and Rehabilitation specialists already working with them in their community.

Additionally, Touch Bionics has always relied on end-user engagement to help guide the future direction of the company. It is important that we get our clients' feedback for the ongoing research and development activities that will lead to the creation of future products and services, many of which will be of direct benefit to our clients.

As a result, we hope that our clients will be open to participating in product trials that will help us improve the lives of other users. This is why we encourage all of the clients that we work with to participate in case studies and outcome studies, wherever possible.

Peace-of-Mind

An important factor for clients is the warranty cover they receive for their prosthetic devices. Touch Bionics has designed a special warranty cover policy with all of its devices, which ensures there is cost no cost to the client for maintenance and repair.

The warranty programme has been developed to give both users and their funding sources confidence in their purchase for the future. Other than warranty cover, the policy also provides free annual service and part upgrades.

- The warranty package on the i-LIMB Hand, i-LIMB Pulse and ProDigits is available for up to a total of three years. In addition, the warranty is offered for both the device and the socket, if fitted with the device.
- Every year the prosthesis can be sent back to Touch Bionics for a complete refurbishment that includes a detailed review of the components of the device(s). If any piece is found to be at issue, it will be replaced at no additional cost.
- During the refurbishment process, the prosthesis will be upgraded with any new software or hardware improvements that have been added for that particular version of the device(s).



Aftercare

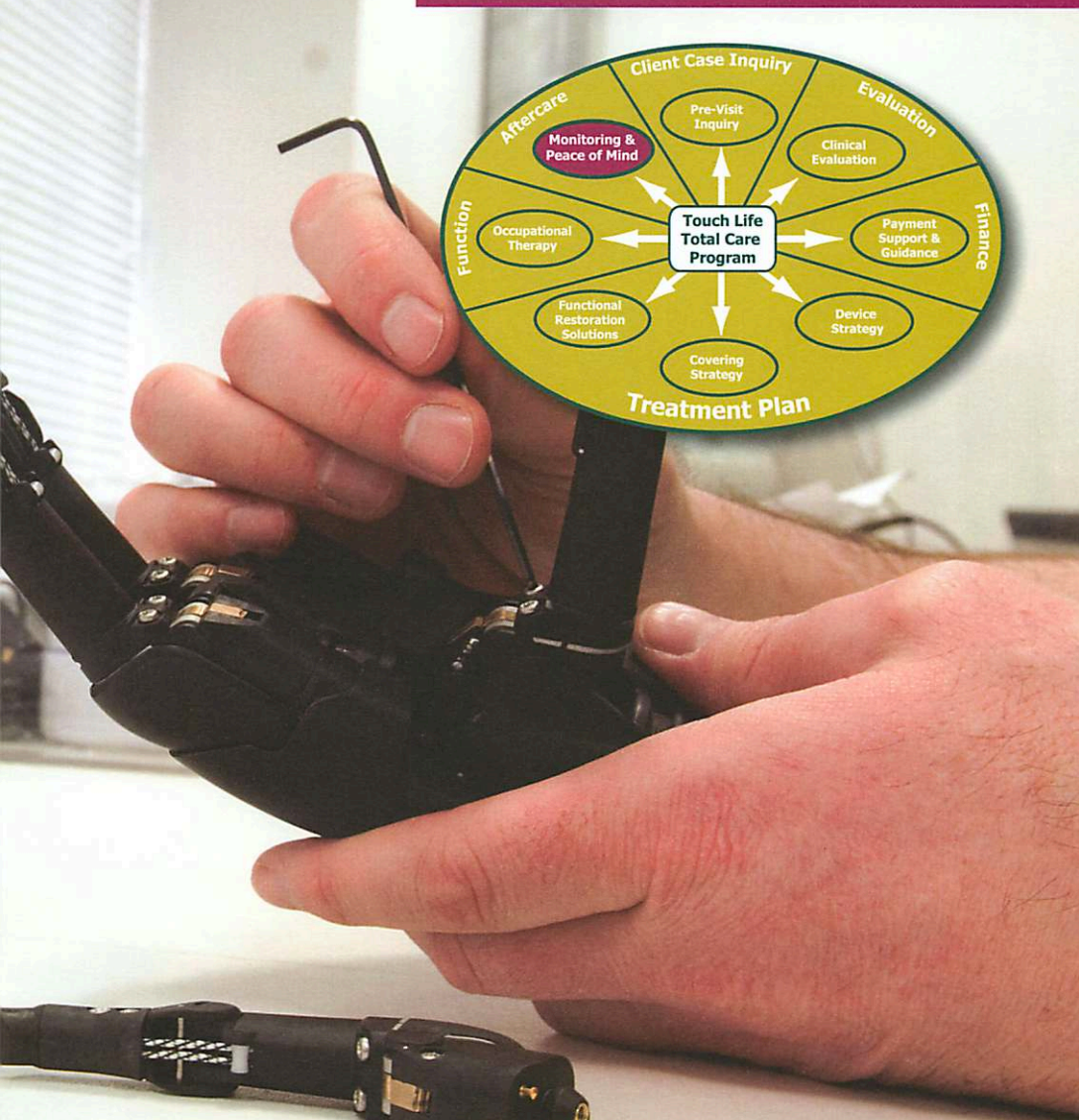

total care

Tel: +44 1506 438 556

Email: info@touchbionics.com

For address details and further information please visit our website:

Website: www.touchbionics.com



Touch Bionics™, LIVINGSKIN™, DermaHair™, i-LIMB™ Hand, SeasonGuard™, i-LIMB™ and ProDigits™ and associated logos are trademarks of Touch EMAS Limited and/or are the subject of trademark applications or registrations in various countries around the world. All Touch EMAS products are subject to continuous research and development – we therefore reserve the right to alter technical specifications without prior notice. Touch EMAS products are protected by patent and/or patent applications in various countries around the world.

TOUCH BIONICS™

Transforming the Everyday Lives
of Extraordinary People



© Copyright 2010 Touch Bionics Inc. and Touch EMAS Ltd. All rights reserved.

Third-party product and brand names may be trademarks or registered trademarks of their respective owners.

Issue No. 2.0 April 2010 Part number: 069109A